

Sonderwerkzeuge

Umformwerkzeug
Rund

System

Salvagnini

PASS STANZTECHNIK AG

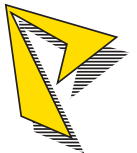

Am Steinkreuz 2
95471 Creußen / Ofr.
Postfach 1260
Telefon: 0 92 70 / 9 85 - 0
Telefax: 0 92 70 / 9 85 - 99

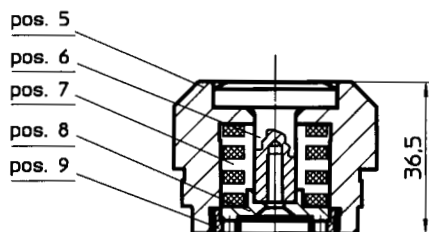
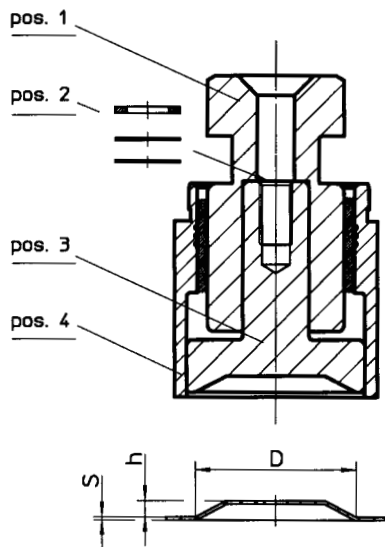

Bestellung

Anfrage

Vorgabedaten:

Machinentyp: _____

Blechstärke: _____

Blechqualität: _____

Abstände der Umformungen: _____

Sonstiges: _____

Blechkizze:



Angebots-Nr.: _____

Datum: _____

Preis „komplett“: _____

Lieferzeit: _____

Kundenanschrift / Firmenstempel:

Sonderwerkzeuge

Mehrfachwerkzeug
in starrer Ausführung

System

Salvagnini

PASS STANZTECHNIK AG



Am Steinkreuz 2
95471 Creußen / Ofr.
Postfach 1260
Telefon: 0 92 70 / 9 85 - 0
Telefax: 0 92 70 / 9 85 - 99

	<div style="display: flex; justify-content: space-around; align-items: center;"> <input type="checkbox"/> Bestellung <input type="checkbox"/> Anfrage </div> <hr/> <p>Vorgabedaten:</p> <p>Machinentyp: _____</p> <p>Blechstärke: _____</p> <p>Blechqualität: _____</p> <p>Sonstiges: _____</p> <hr/> <p>Blechkizze: (Lochbild)</p> <div style="border: 1px solid black; width: 100%; height: 150px; background-image: linear-gradient(to right, black 1px, transparent 1px), linear-gradient(to bottom, black 1px, transparent 1px); background-size: 20px 20px;"> <!-- Grid content --> </div>
<p>Angebots-Nr.: _____ Datum: _____</p> <p>Preis „komplett“: _____</p> <p>Lieferzeit: _____</p>	
<p>Kundenanschrift / Firmenstempel:</p>	

Sonderwerkzeuge

Mehrfachwerkzeug
in starrer Ausführung

System

Salvagnini

PASS STANZTECHNIK AG

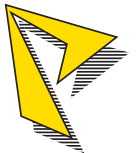

Am Steinkreuz 2
95471 Creußen / Ofr.
Postfach 1260
Telefon: 0 92 70 / 9 85 - 0
Telefax: 0 92 70 / 9 85 - 99

	<div style="display: flex; justify-content: space-between; align-items: center;"> <input type="checkbox"/> Bestellung <input type="checkbox"/> Anfrage </div> <hr/> <p>Vorgabedaten:</p> <p>Machinentyp: _____</p> <p>Blechstärke: _____</p> <p>Blechqualität: _____</p> <p>Sonstiges: _____</p> <hr/> <p>Blechkizze: (Lochbild)</p> <div style="border: 1px solid black; width: 100%; height: 150px; background-image: linear-gradient(to right, transparent 49%, #ccc 49% 49%, #ccc 49% 51%, transparent 51%); background-size: 20px 20px;"></div>
<p>Angebots-Nr.: _____ Datum: _____</p> <p>Preis „komplett“: _____</p> <p>Lieferzeit: _____</p>	
<p>Kundenanschrift / Firmenstempel:</p>	

Sonderwerkzeuge

Mehrfachwerkzeug
mit gefedertem Niederhalter

System

Salvagnini

PASS STANZTECHNIK AG

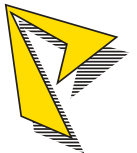

Am Steinkreuz 2
95471 Creußen / Ofr.
Postfach 1260
Telefon: 0 92 70 / 9 85 - 0
Telefax: 0 92 70 / 9 85 - 99

	<div style="display: flex; justify-content: space-between; align-items: center;"> <input type="checkbox"/> Bestellung <input type="checkbox"/> Anfrage </div> <hr/> <p>Vorgabedaten:</p> <p>Machinentyp: _____</p> <p>Blechstärke: _____</p> <p>Blechqualität: _____</p> <p>Sonstiges: _____</p> <hr/> <p>Blechskizze: (Lochbild)</p> <div style="border: 1px solid black; width: 100%; height: 150px; background-image: linear-gradient(to right, black 1px, transparent 1px), linear-gradient(to bottom, black 1px, transparent 1px); background-size: 20px 20px;"> </div>
<p>Angebots-Nr.: _____ Datum: _____</p> <p>Preis „komplett“: _____</p> <p>Lieferzeit: _____</p>	
<p>Kundenanschrift / Firmenstempel:</p>	

Sonderwerkzeuge

Durchzugswerkzeug

System

Salvagnini

PASS STANZTECHNIK AG



Am Steinkreuz 2
 95471 Creußen / Ofr.
 Postfach 1260
 Telefon: 0 92 70 / 9 85 - 0
 Telefax: 0 92 70 / 9 85 - 99

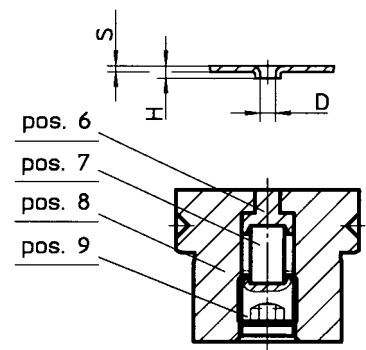
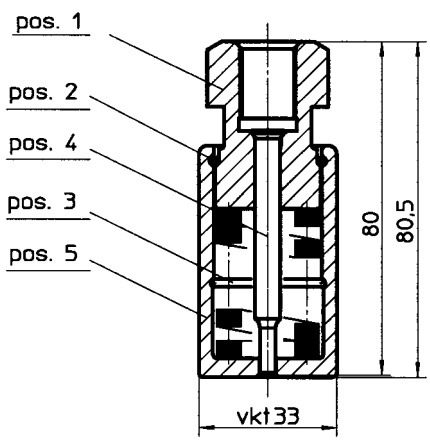

Bestellung

Anfrage

Vorgabedaten:

Machinentyp: _____

Blechstärke: _____

Blechqualität: _____

Sonstiges: _____

Blechkizze: (oder Maße H/D angeben)



Angebots-Nr.: _____

Datum: _____

Preis „komplett“: _____

Lieferzeit: _____

Kundenanschrift / Firmenstempel:

Sonderwerkzeuge

Mehrfachwerkzeug
mit Maschinenabstreifer

System

Salvagnini

PASS STANZTECHNIK AG

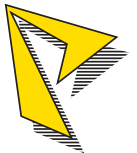

Am Steinkreuz 2
95471 Creußen / Ofr.
Postfach 1260
Telefon: 0 92 70 / 9 85 - 0
Telefax: 0 92 70 / 9 85 - 99

<p>pos. 1</p> <p>pos. 2</p> <p>pos. 3</p> <p>pos. 4</p> <p>pos. 5</p> <p>81.5</p> <p>S=___mm</p> <p>pos. 6</p> <p>vkt 44</p> <p>15</p>	<div style="display: flex; justify-content: space-around; align-items: center;"> <input type="checkbox"/> Bestellung <input type="checkbox"/> Anfrage </div> <hr/> <p>Vorgabedaten:</p> <p>Machinentyp: _____</p> <p>Blechstärke: _____</p> <p>Blechqualität: _____</p> <p>Sonstiges: _____</p> <p>_____</p> <p>_____</p> <p>_____</p> <hr/> <p>Blechkizze: (Lochbild)</p> <div style="border: 1px solid black; width: 100%; height: 150px; background-image: linear-gradient(to right, 1px solid black, 1px solid transparent); background-size: 10px 10px;"> <!-- Grid content --> </div>
<p>Angebots-Nr.: _____ Datum: _____</p> <p>Preis „komplett“: _____</p> <p>Lieferzeit: _____</p>	
<p>Kundenanschrift / Firmenstempel:</p>	

Sonderwerkzeuge

Mehrfachwerkzeug
mit gefedertem Niederhalter

System

Salvagnini

PASS STANZTECHNIK AG

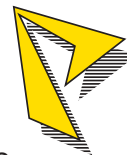

Am Steinkreuz 2
95471 Creußen / Ofr.
Postfach 1260
Telefon: 0 92 70 / 9 85 - 0
Telefax: 0 92 70 / 9 85 - 99

<p>pos. 1</p> <p>pos. 2</p> <p>pos. 3</p> <p>pos. 4</p> <p>pos. 5</p> <p>pos. 6</p> <p>pos. 7</p> <p>pos. 8</p> <p>S=___mm</p> <p>pos. 9</p>	<div style="display: flex; justify-content: space-around; align-items: center;"> <input type="checkbox"/> Bestellung <input type="checkbox"/> Anfrage </div> <hr/> <p>Vorgabedaten:</p> <p>Machinentyp: _____</p> <p>Blechstärke: _____</p> <p>Blechqualität: _____</p> <p>Sonstiges: _____</p> <hr/> <p>Blechkizze: (Lochbild)</p> <div style="border: 1px solid black; width: 100%; height: 150px; background-image: linear-gradient(to right, 1px solid black 1px, transparent 1px), linear-gradient(to bottom, 1px solid black 1px, transparent 1px); background-size: 20px 20px;"> <!-- Grid content --> </div>
<p>Angebots-Nr.: _____ Datum: _____</p> <p>Preis „komplett“: _____</p> <p>Lieferzeit: _____</p>	
<p>Kundenanschrift / Firmenstempel:</p>	

Sonderwerkzeuge

Umformwerkzeug
Rund

System

Salvagnini

PASS STANZTECHNIK AG

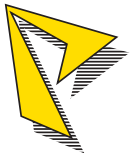

Am Steinkreuz 2
95471 Creußen / Ofr.
Postfach 1260
Telefon: 0 92 70 / 9 85 - 0
Telefax: 0 92 70 / 9 85 - 99

<p>pos. 1</p> <p>pos. 2</p> <p>pos. 3</p> <p>80,5</p> <p>s</p> <p>h</p> <p>D</p> <p>pos. 4</p> <p>pos. 5</p> <p>pos. 6</p> <p>pos. 7</p> <p>36,5</p> <p>Ø 35,5</p>	<input type="checkbox"/> Bestellung <input type="checkbox"/> Anfrage
	<p>Vorgabedaten:</p> <p>Machinentyp: _____</p> <p>Blechstärke: _____</p> <p>Blechqualität: _____</p> <p>Abstände: _____</p> <p>Umformung: _____</p> <p>Sonstiges: _____</p>
<p>Angebots-Nr.: _____ Datum: _____</p> <p>Preis „komplett“: _____</p> <p>Lieferzeit: _____</p>	<p>Blechskizze:</p>
<p>Kundenanschrift / Firmenstempel:</p>	

Sonderwerkzeuge

Umformwerkzeug
Langloch

System

Salvagnini

PASS STANZTECHNIK AG



Am Steinkreuz 2
95471 Creußen / Ofr.
Postfach 1260
Telefon: 0 92 70 / 9 85 - 0
Telefax: 0 92 70 / 9 85 - 99

	<div style="display: flex; justify-content: space-between;"> <input type="checkbox"/> Bestellung <input type="checkbox"/> Anfrage </div> <p>Vorgabedaten:</p> <p>Machinentyp: _____</p> <p>Blechstärke: _____</p> <p>Blechqualität: _____</p> <p>Abstände der Umformungen: _____</p> <p>Sonstiges: _____</p> <hr/> <p>Blechskizze: (oder Maße h/A/B angeben)</p> <div style="border: 1px solid black; width: 100%; height: 150px; background-image: linear-gradient(to right, black 1px, transparent 1px), linear-gradient(to bottom, black 1px, transparent 1px); background-size: 20px 20px;"> </div>
<p>Angebots-Nr.: _____ Datum: _____</p> <p>Preis „komplett“: _____</p> <p>Lieferzeit: _____</p>	
<p>Kundenanschrift / Firmenstempel:</p>	

Sonderwerkzeuge

Kiemenwerkzeug
gfedert

System

Salvagnini

PASS STANZTECHNIK AG

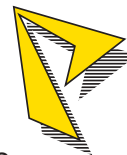

Am Steinkreuz 2
95471 Creußen / Ofr.
Postfach 1260
Telefon: 0 92 70 / 9 85 - 0
Telefax: 0 92 70 / 9 85 - 99

	<div style="display: flex; justify-content: space-between; align-items: center;"> <input type="checkbox"/> Bestellung <input type="checkbox"/> Anfrage </div> <hr/> <p>Vorgabedaten:</p> <p>Machinentyp: _____</p> <p>Blechstärke: _____</p> <p>Blechqualität: _____</p> <p>Sonstiges: _____</p> <p>_____</p> <p>_____</p> <p>_____</p> <hr/> <p>Blechkizze: (oder Maße s / b / h / y / x angeben)</p> <div style="border: 1px solid black; width: 100%; height: 150px; background-image: linear-gradient(to right, black 1px, transparent 1px), linear-gradient(to bottom, black 1px, transparent 1px); background-size: 20px 20px;"> </div>
<p>Angebots-Nr.: _____ Datum: _____</p> <p>Preis „komplett“: _____</p> <p>Lieferzeit: _____</p>	
<p>Kundenanschrift / Firmenstempel:</p>	

Sonderwerkzeuge

Umformwerkzeug
Lasche

System

Salvagnini

PASS STANZTECHNIK AG

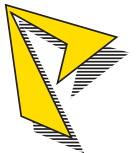

Am Steinkreuz 2
95471 Creußen / Ofr.
Postfach 1260
Telefon: 0 92 70 / 9 85 - 0
Telefax: 0 92 70 / 9 85 - 99

	<div style="display: flex; justify-content: space-between;"> <input type="checkbox"/> Bestellung <input type="checkbox"/> Anfrage </div> <p>Vorgabedaten:</p> <p>Machinentyp: _____</p> <p>Blechstärke: _____</p> <p>Blechqualität: _____</p> <p>Abstände der Umformungen: _____</p> <p>Sonstiges: _____</p> <p>Blechskizze: (oder Maße b / h / l angeben)</p> <div style="border: 1px solid black; width: 100%; height: 150px; background-image: linear-gradient(to right, lightgray 1px, transparent 1px), linear-gradient(to bottom, lightgray 1px, transparent 1px); background-size: 20px 20px;"> <!-- Grid content --> </div>
<p>Angebots-Nr.: _____ Datum: _____</p> <p>Preis „komplett“: _____</p> <p>Lieferzeit: _____</p>	
<p>Kundenanschrift / Firmenstempel:</p>	

Sonderwerkzeuge

Ansenkwerkzeug

System

Salvagnini

PASS STANZTECHNIK AG



Am Steinkreuz 2
95471 Creußen / Ofr.
Postfach 1260
Telefon: 0 92 70 / 9 85 - 0
Telefax: 0 92 70 / 9 85 - 99

	<div style="display: flex; justify-content: space-between; align-items: center;"> <input type="checkbox"/> Bestellung <input type="checkbox"/> Anfrage </div> <p>Vorgabedaten:</p> <p>Machinentyp: _____</p> <p>Blechstärke: _____</p> <p>Blechqualität: _____</p> <p>Sonstiges: _____</p> <hr/> <p>Blechskizze: (oder Maße D / d / h angeben)</p> <div style="border: 1px solid black; width: 100%; height: 150px; background-image: linear-gradient(to right, transparent 49%, #ccc 49% 49%, #ccc 49% 51%, transparent 51%); background-size: 20px 20px;"> </div>
<p>Angebots-Nr.: _____ Datum: _____</p> <p>Preis „komplett“: _____</p> <p>Lieferzeit: _____</p>	
<p>Kundenanschrift / Firmenstempel:</p>	

Sonderwerkzeuge

Zentrierwarzenwerkzeug

System

Salvagnini

PASS STANZTECHNIK AG

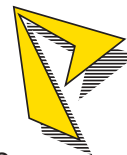

Am Steinkreuz 2
 95471 Creußen / Ofr.
 Postfach 1260
 Telefon: 0 92 70 / 9 85 - 0
 Telefax: 0 92 70 / 9 85 - 99

	<div style="display: flex; justify-content: space-between; align-items: center;"> <input type="checkbox"/> Bestellung <input type="checkbox"/> Anfrage </div> <hr/> <p>Vorgabedaten:</p> <p>Machinentyp: _____</p> <p>Blechstärke: _____</p> <p>Blechqualität: _____</p> <p>Sonstiges: _____</p> <hr/> <p>Blechskizze:</p> <div style="border: 1px solid black; width: 100%; height: 150px; background-image: linear-gradient(to right, black 1px, transparent 1px), linear-gradient(to bottom, black 1px, transparent 1px); background-size: 20px 20px;"> </div>
<p>Angebots-Nr.: _____ Datum: _____</p> <p>Preis „komplett“: _____</p> <p>Lieferzeit: _____</p>	
<p>Kundenanschrift / Firmenstempel:</p>	

Sonderwerkzeuge

Mehrfachwerkzeug
mit gefedertem Niederhalter

System

Salvagnini

PASS STANZTECHNIK AG

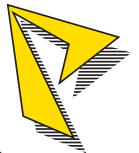

Am Steinkreuz 2
95471 Creußen / Ofr.
Postfach 1260
Telefon: 0 92 70 / 9 85 - 0
Telefax: 0 92 70 / 9 85 - 99

<p>pos. 1 pos. 2 pos. 3 pos. 4 pos. 3 pos. 4 pos. 7 pos. 8</p> <p>S=...mm</p> <p>pos. 9</p> <p>80.5 81</p> <p>12 17</p>	<input type="checkbox"/> Bestellung <input type="checkbox"/> Anfrage
	<p>Vorgabedaten:</p> <p>Machinentyp: _____</p> <p>Blechstärke: _____</p> <p>Blechqualität: _____</p> <p>Sonstiges: _____</p> <p>_____</p> <p>_____</p> <p>_____</p>
<p>Angebots-Nr.: _____ Datum: _____</p> <p>Preis „komplett“: _____</p> <p>Lieferzeit: _____</p>	<p>Blechskizze:</p>
<p>Kundenanschrift / Firmenstempel:</p> 	

Sonderwerkzeuge

Umformwerkzeug
Rund

System

Salvagnini

PASS STANZTECHNIK AG



Am Steinkreuz 2
95471 Creußen / Ofr.
Postfach 1260
Telefon: 0 92 70 / 9 85 - 0
Telefax: 0 92 70 / 9 85 - 99

	<div style="display: flex; justify-content: space-around; align-items: center;"> <input type="checkbox"/> Bestellung <input type="checkbox"/> Anfrage </div> <p>Vorgabedaten:</p> <p>Machinentyp: _____</p> <p>Blechstärke: _____</p> <p>Blechqualität: _____</p> <p>Abstände der Umformungen: _____</p> <p>Sonstiges: _____</p> <p>Blechskizze:</p> <div style="border: 1px solid black; height: 200px; width: 100%; background-image: linear-gradient(to right, lightgray 1px, transparent 1px), linear-gradient(to bottom, lightgray 1px, transparent 1px); background-size: 20px 20px;"> <!-- Grid content --> </div>
<p>Angebots-Nr.: _____ Datum: _____</p> <p>Preis „komplett“: _____</p> <p>Lieferzeit: _____</p>	
<p>Kundenanschrift / Firmenstempel:</p>	