

WILA

TRUMPF

EUROPEAN

LVD

BYSTRONIC

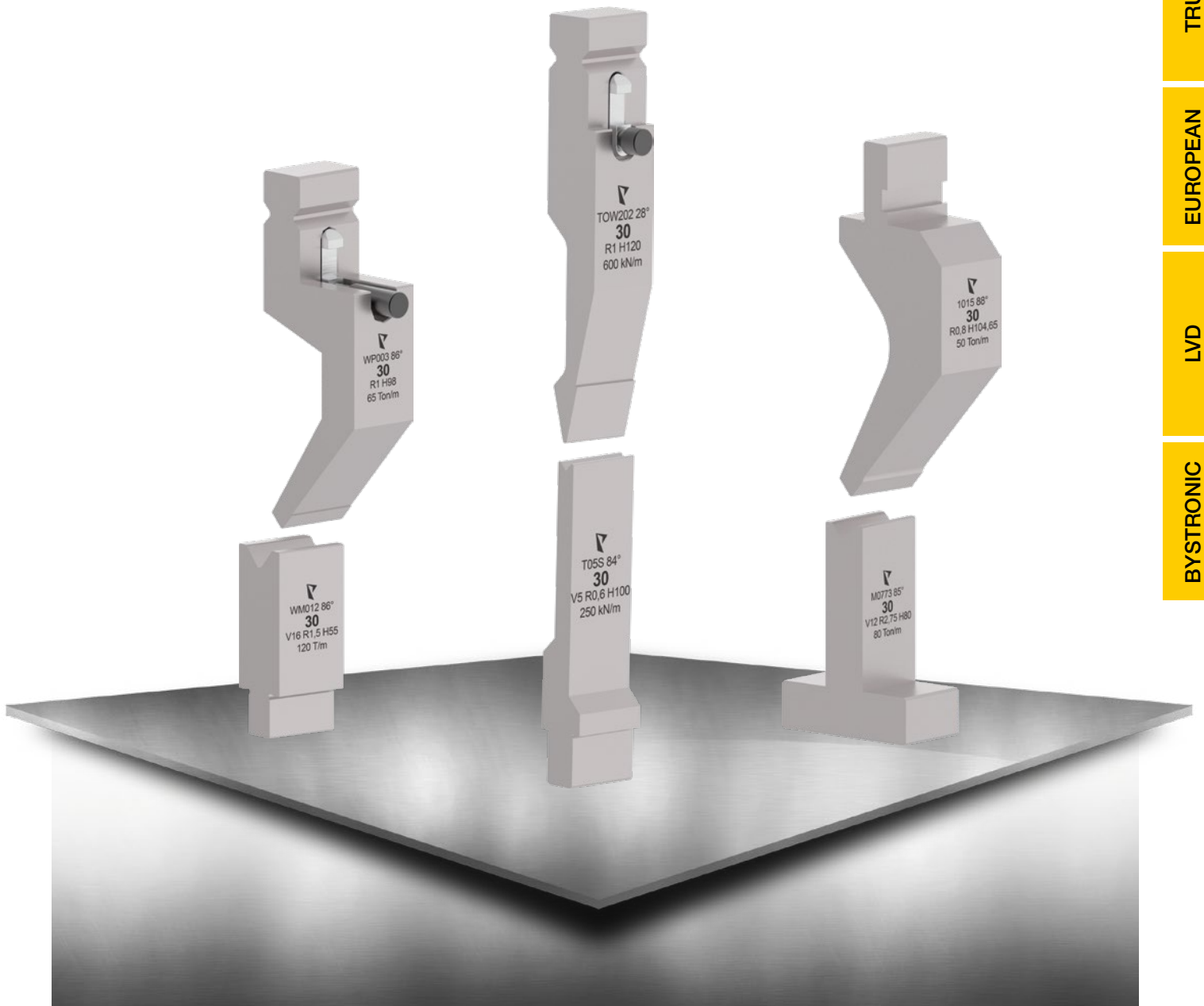

PRODUCT PORTFOLIO PRESS BRAKE 03/2026
SYSTEM WILA, TRUMPF, EUROPEAN,
LVD & BYSTRONIC

PRODUCT PORTFOLIO

FOR TOOLING SYSTEM WILA, TRUMPF, EUROPEAN, LVD & BYSTRONIC

THANK YOU VERY MUCH,

for your interest in a tool produced by PASS Stanztechnik AG.

With this brochure we would like to introduce you to our product portfolio. Therefore, we have prepared this document for you including the most important tools from the tooling system WILA, TRUMPF, EUROPEAN, LVD & BYSTRONIC.

Please feel free to contact us in any case of questions.

Yours

PASS Stanztechnik AG

FOR TOOLING SYSTEM WILA, TRUMPF, EUROPEAN, LVD & BYSTRONIC

PRESS BRAKE TOOLS STANDARD

for tooling system WILA page 4
for tooling system TRUMPF page 5
for tooling system EUROPEAN page 6
for tooling system LVD page 7
for tooling system BYSTRONIC..... page 8

PRESS BRAKE TOOLS SPECIAL

for tooling system WILA, TRUMPF, EUROPEAN, LVD & BYSTRONIC page 9

EXPRESS CLAMP

for tooling system WILA, TRUMPF & EUROPEANpage 12

ADAPTER AND INTERMEDIATES

for tooling system WILA, TRUMPF, EUROPEAN, LVD & BYSTRONICpage 13

PRESS BRAKE TOOLS STANDARD

FOR TOOLING SYSTEM WILA

WILA

- tools in market based sections
- material: 42CrMo4
- safety button as a standard for punches up to 12,7 kg
- induction hardened

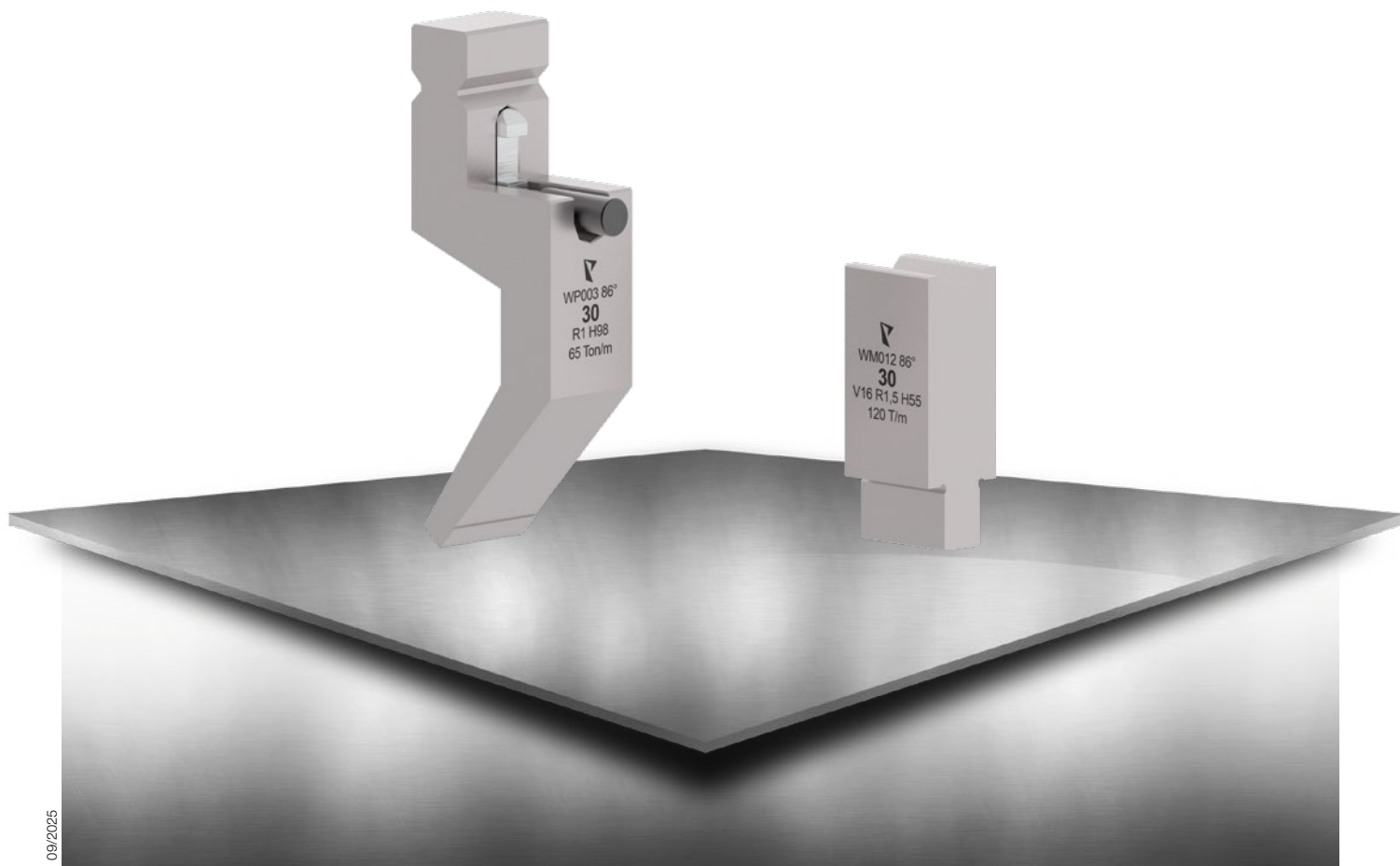

09/2025

PRESS BRAKE TOOLS STANDARD

FOR TOOLING SYSTEM TRUMPF

- tools in market based sections
- material: 42CrMo4
- safety button as a standard for punches up to 12,7 kg
- induction hardened

TRUMPF

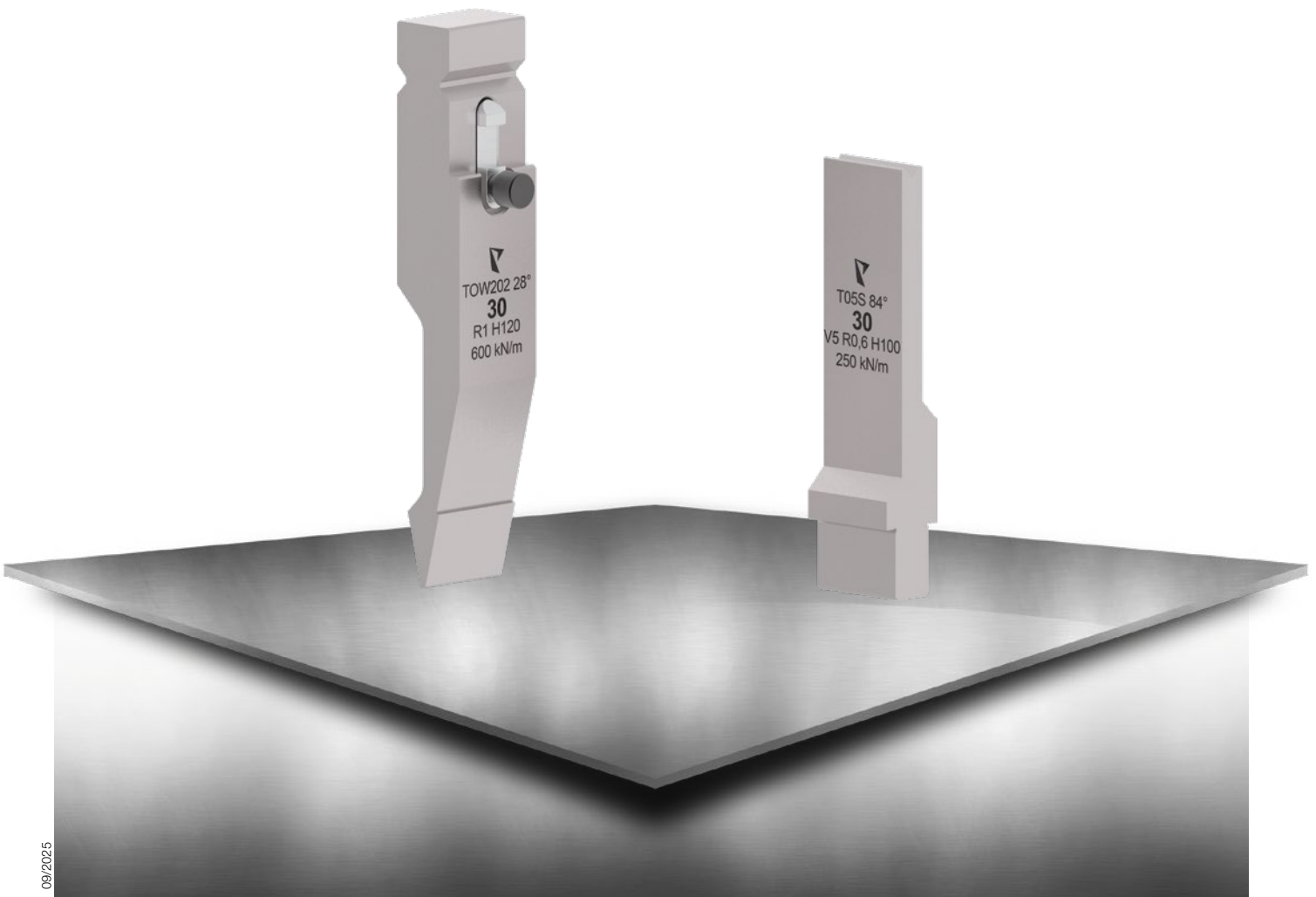

09/2025

PRESS BRAKE TOOLS STANDARD

FOR TOOLING SYSTEM EUROPEAN

- tools in market based sections
- induction hardened
- material: 42CrMo4
- cost-effective material alternative (C45) on request

EUROPEAN

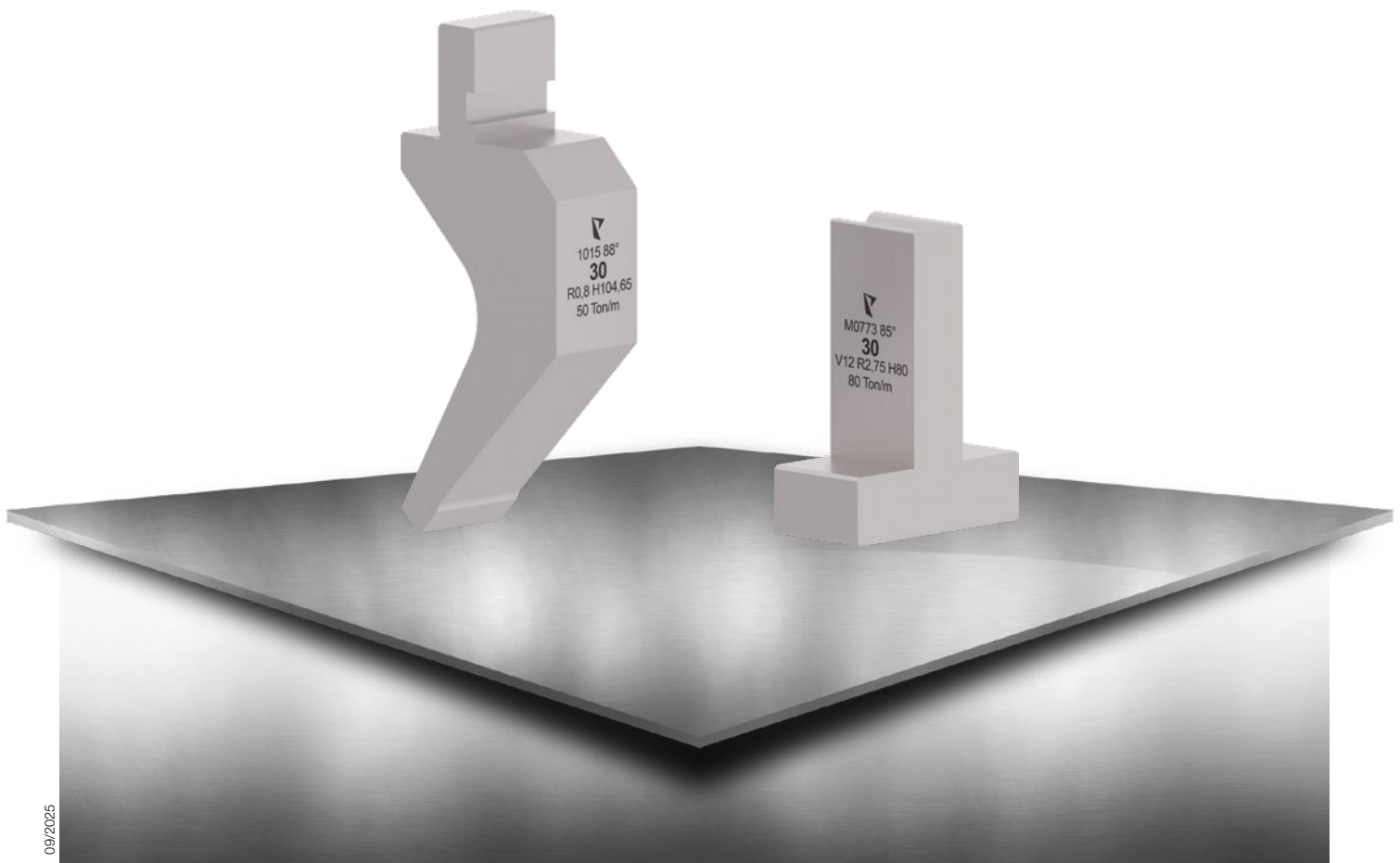

09/2025

PRESS BRAKE TOOLS STANDARD

FOR TOOLING SYSTEM LVD

- tools in market based sections
- material: 42CrMo4
- punches available with different shaft profiles (LVD10 / LVD15 / WT)
- induction hardened

LVD10

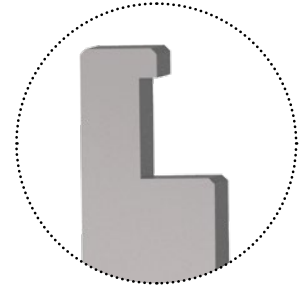

LVD15

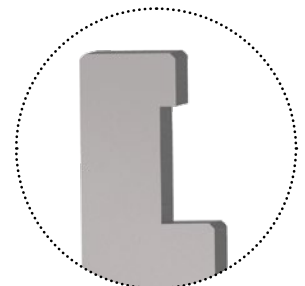

WT

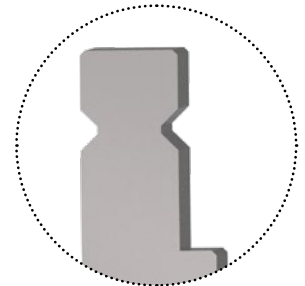

LVD

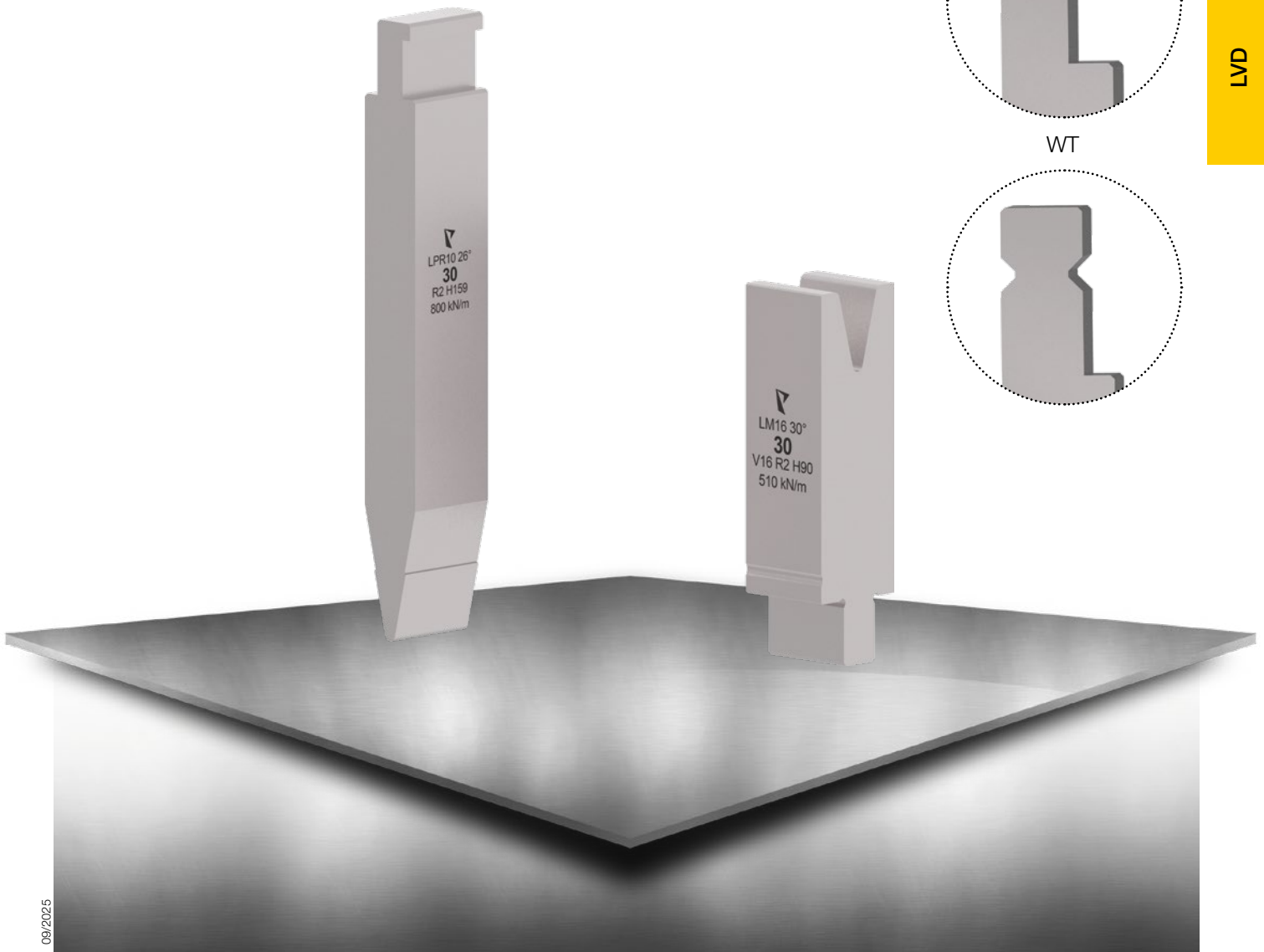

PRESS BRAKE TOOLS STANDARD

FOR TOOLING SYSTEM BYSTRONIC

- tools in market based sections
- material: 42CrMo4
- punches available with different shaft profiles (Bystronic R / RFA)
- induction hardened

Bystronic R

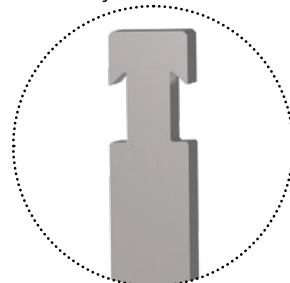

Bystronic RFA

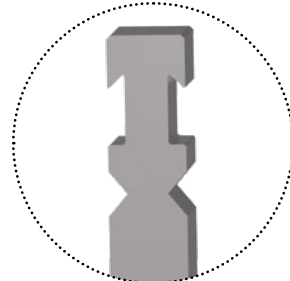

BYSTRONIC

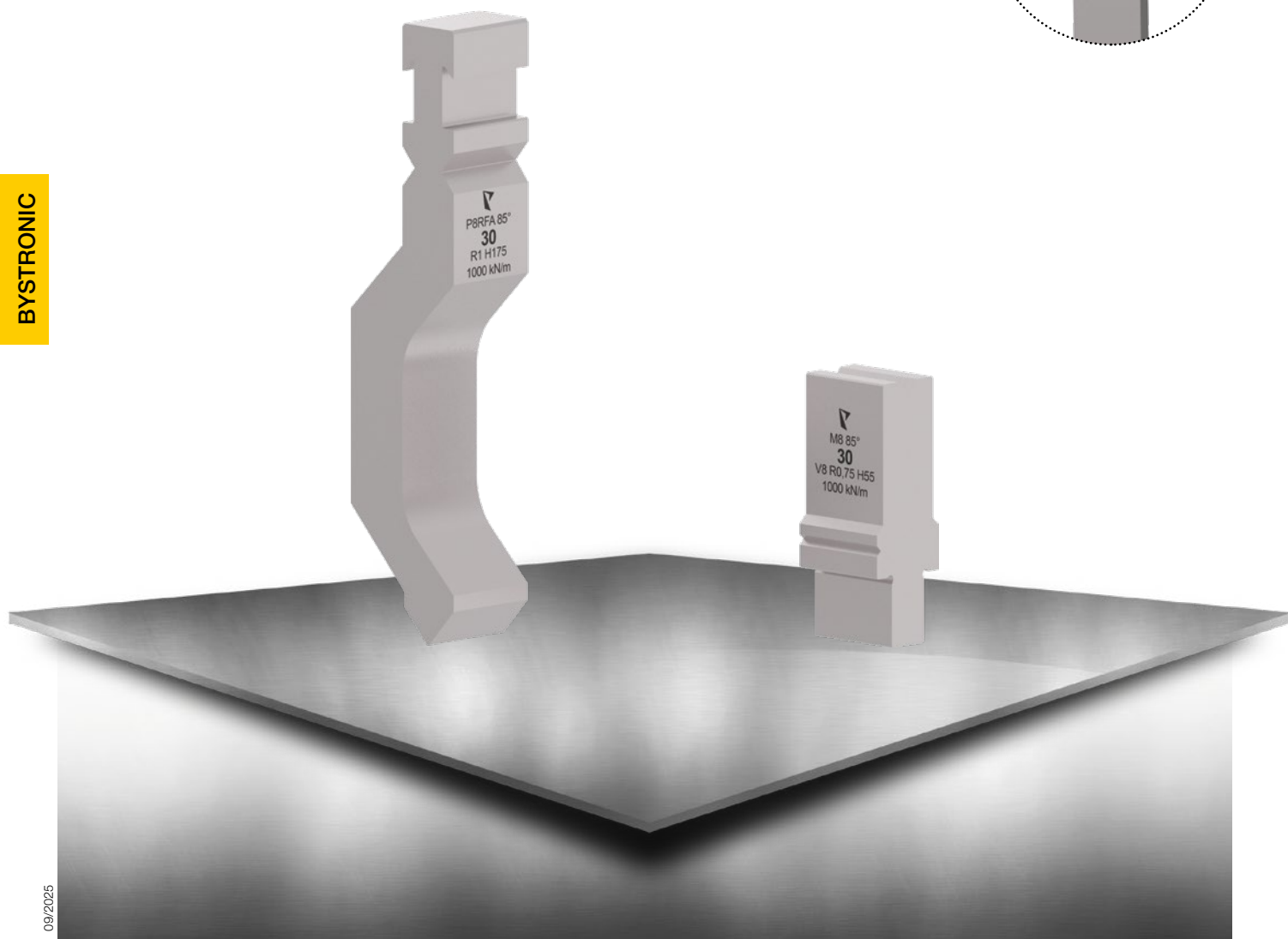

09/2025

PRESS BRAKE TOOLS SPECIAL

FOR TOOLING SYSTEM WILA, TRUMPF, EUROPEAN, LVD & BYSTRONIC

Hemming tools:

- production of a bending with 2 hits
- pre-bending and hemming with 1 tool

Radius tool:

- with interchangeable bending inserts
- EUROPEAN:
R 3 mm - R 50 mm
- WILA/TRUMPF:
R 10 mm - R 50 mm
- other radii available on request

Z-bending tools:

- with interchangeable bending inserts
- EUROPEAN:
H 1 mm - H 15 mm
- WILA/TRUMPF:
H 4 mm - H 10 mm
- other offset heights available on request

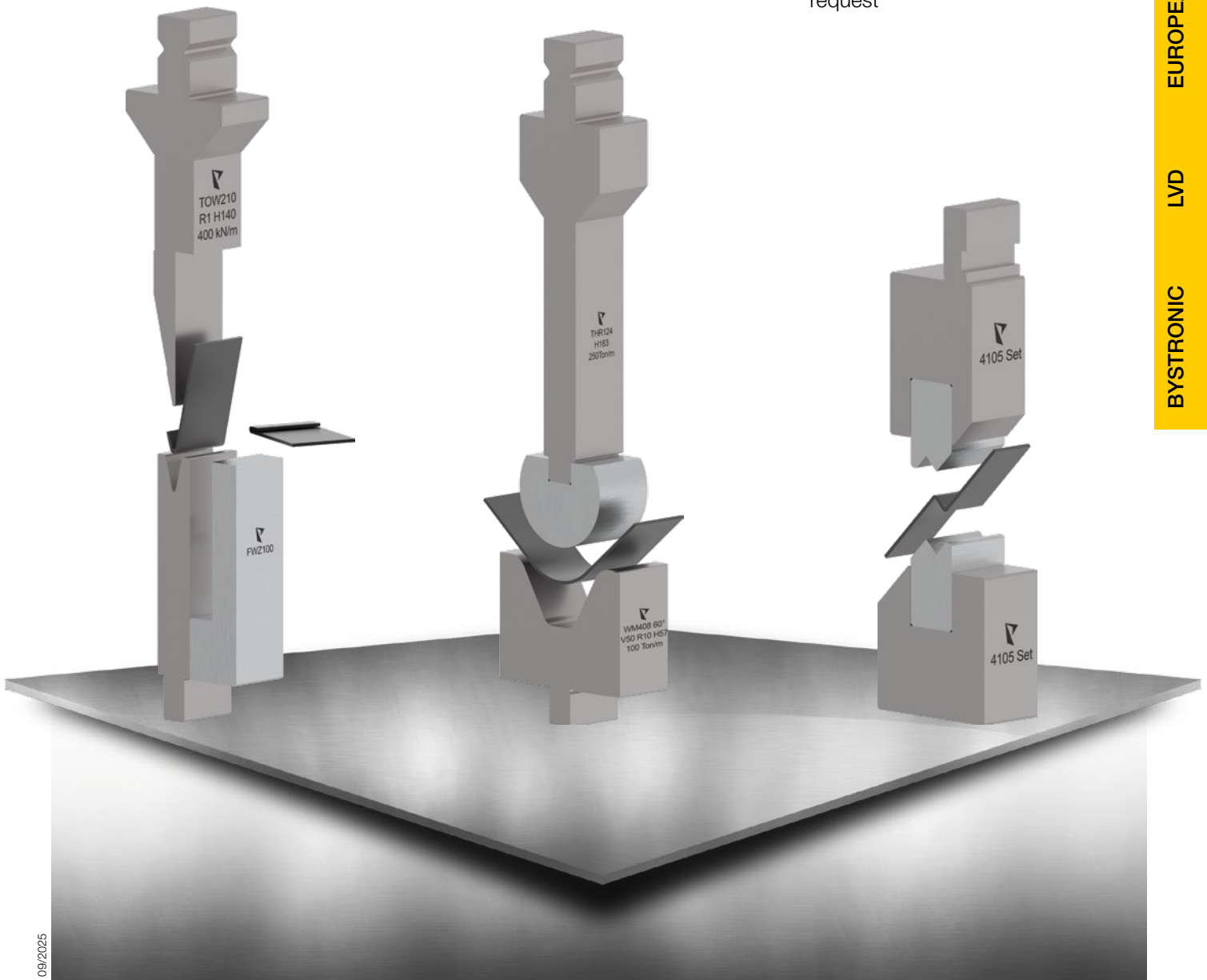

09/2025

PRESS BRAKE TOOLS SPECIAL

FOR TOOLING SYSTEM WILA, TRUMPF, EUROPEAN, LVD & BYSTRONIC

WILA

TRUMPF

EUROPEAN

LVD

BYSTRONIC

- efficient special solutions for complex bending processes
- multiple bendings and complex geometries in a single bending step
- modular design with interchangeable bending inserts
- produced according to customer-specific functional requirements

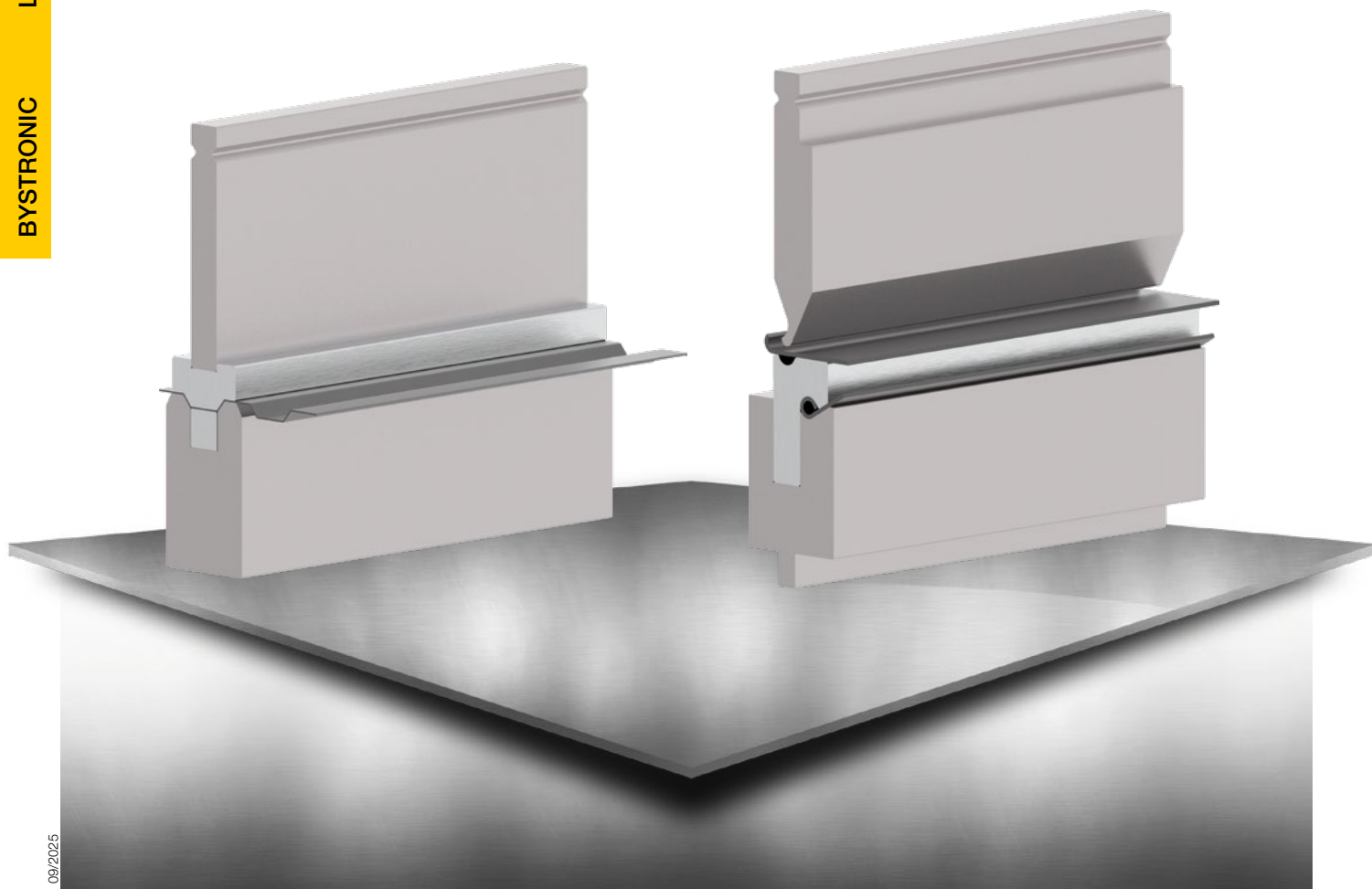

09/2025

PRESS BRAKE TOOLS SPECIAL

FOR TOOLING SYSTEM WILA, TRUMPF, EUROPEAN, LVD & BYSTRONIC

- efficient special solutions for complex bending processes
- multiple bendings and complex geometries in a single bending step
- modular design with interchangeable bending inserts
- produced according to customer-specific functional requirements

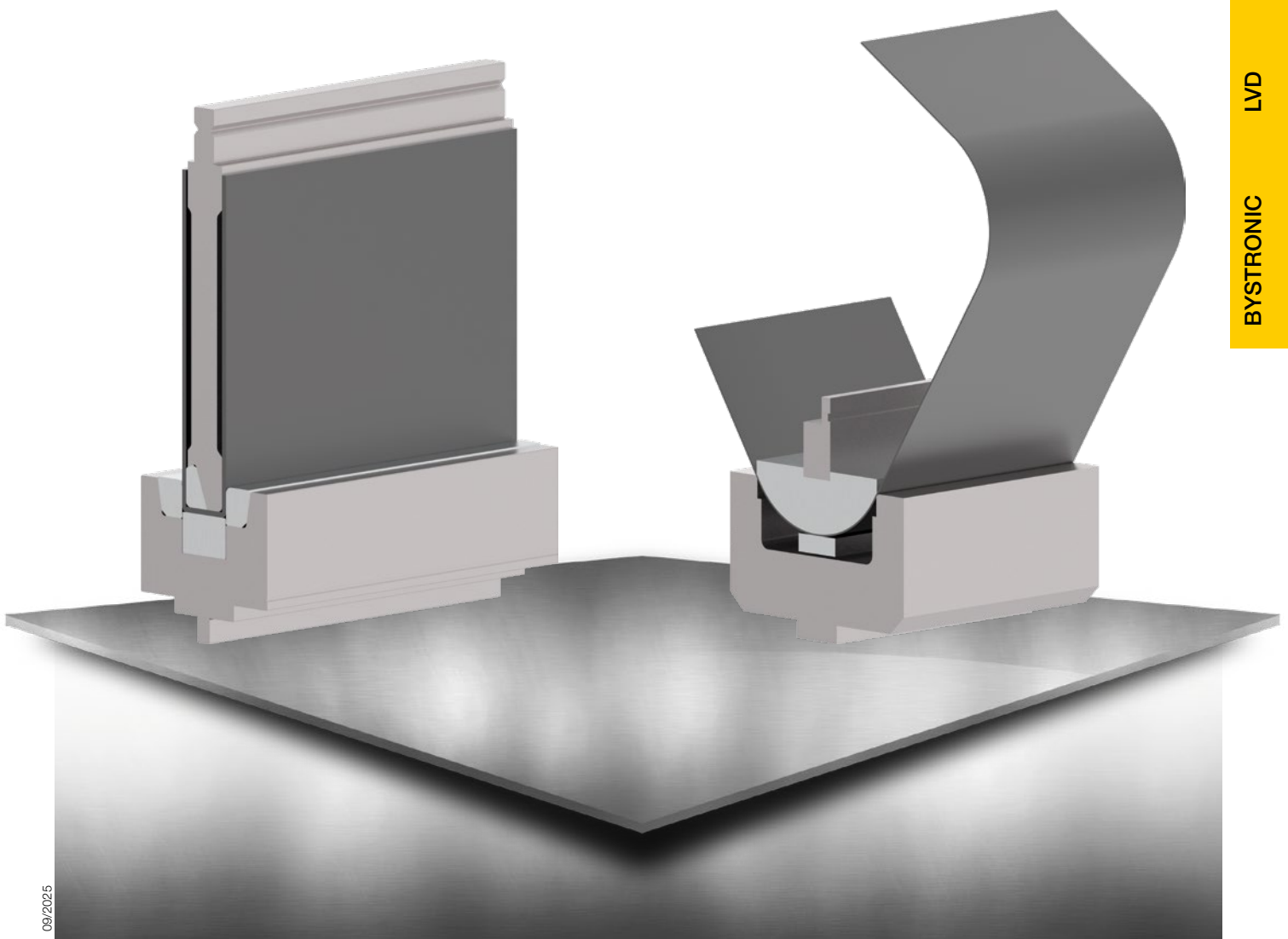

WILA

TRUMPF

EUROPEAN

LVD

BYSTRONIC

09/2025

EXPRESS CLAMP

FOR TOOLING SYSTEM WILA, TRUMPF & EUROPEAN

WILA

- clamping system for tooling system EUROPEAN

TRUMPF

- also available with adaptation to tooling system WILA and TRUMPF

EUROPEAN

- precise alignment of several clamps mounted in a row

- upper tools can be loaded from below or from the side

- locking system with lever for fast setting-up

- front and rear clamping plates are getting locked in the same time

- Nitrex® heat treatment for maximum durability

- precise positioning of even short upper tools

- slim desing allows narrow bendings

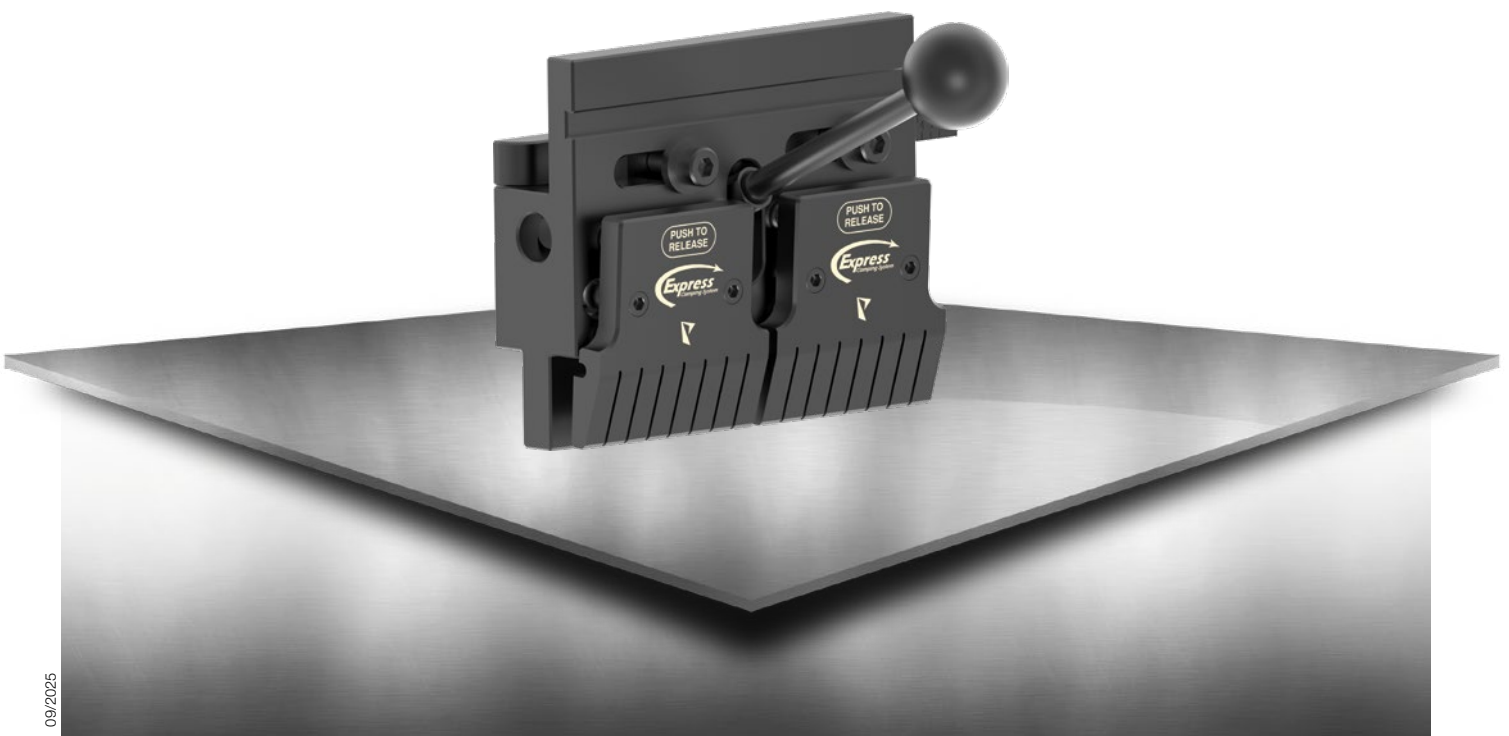

09/2025

ADAPTER AND INTERMEDIATES

FOR TOOLING SYSTEM WILA, TRUMPF, EUROPEAN, LVD & BYSTRONIC

- various adaptations and extensions possible
- available on both punch and die sides
- height adjustment to achieve tool compatibility
- combination of tools from different systems
- reduction in tool variety through use of existing tool sets
- higher productivity thanks to quick-change adapters
- increased flexibility

WILA

TRUMPF

EUROPEAN

LVD

BYSTRONIC

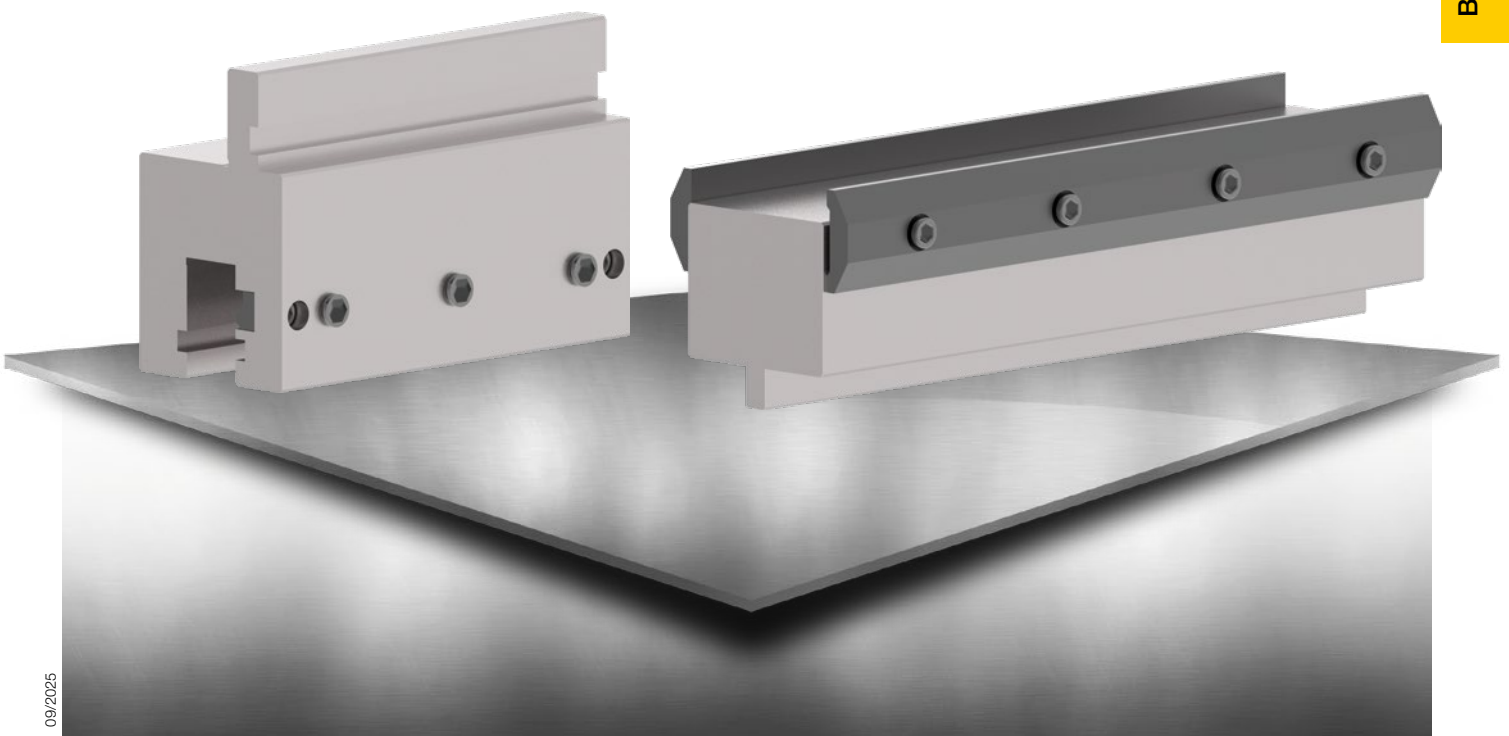

09/2025

NOTES

A large grid of graph paper for taking notes, consisting of 20 columns and 30 rows of small squares.

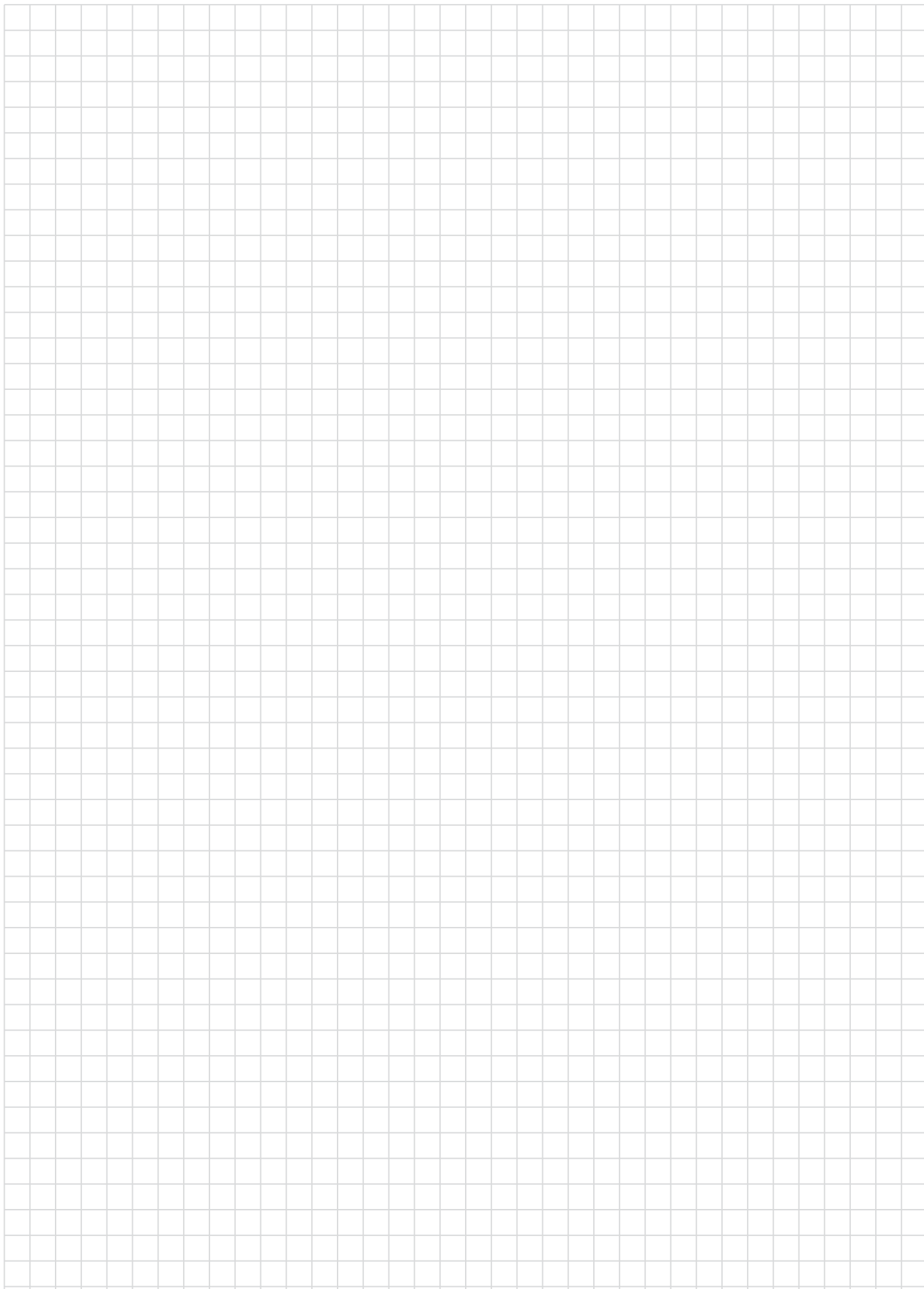

WILA | TRUMPF | EUROPEAN | LVD | BYSTRONIC



Am Steinkreuz 2
95473 Creußen | Germany

WEB: www.pass-ag.com
MAIL: info@pass-ag.com

FON: +49 (0) 92 70 / 9 85 - 0
FAX: +49 (0) 92 70 / 9 85 - 99